

3-LIGHTS FOLIA LEFT SUSP UNIT

TECHNICAL DATA SHEET



FEATURES

Product name 3-LIGHTS LEFT MODULE SUSP FOLIA
 Code **7Y03aLbcddee**
 a = 1 : Europe / 3 : US
 b = 1 : gold / 2 : chrome plated
 c = 6 : dark ash / 7 : clear ash / 8 : white ash
 dd = 00 : clear crystal / 25 : chartreuse green crystal / ZZ : without crystal
 ee = (use 1 digit in a) Ø : version standard / CN : China version (CCC) / SA : Middle East version / TW : Taiwan version (BSMI) / EG : Egypt version / MA : Morocco version / GB : United Kingdom version
 (use 3 digit in a) US : USA version / JP : Japan version

Material Gold brushed anodized aluminium / chrome plated aluminium, ash wood, clear crystal

Electrical class Class II
 220-240V 50/60Hz (EUROPE, GB, CN, SA, SG VERSION)

Voltage 100-127V 50/60Hz (US, JP VERSION)

IP 20

Installation Inside

Mounting Suspension

DIMENSIONS

L x l 96cm (37,8in) x 30cm (11,8in)

Height 14,5cm (5,5in)

Weight 4,2 kg

Adjustable height 2m max. (78,7in max.)

NOT INCLUDED SOURCES

Category HALOGEN
 Quantity 3
 Lbs D45
 Watt 40 W max.
 Socket E14 (EUROPE, SASO & CHINA VERSION)
 E12 (US VERSION)

ALTERNATIVE SOURCES

Category LED RETROFIT
 Quantity 3
 Lbs D45
 Watt 5 W max.
 Socket E14 (EUROPE, SASO & CHINA VERSION)
 E12 (US VERSION)

ELECTRICAL DIAGRAM

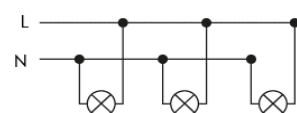

MAINTENANCE



SILHOUETTE

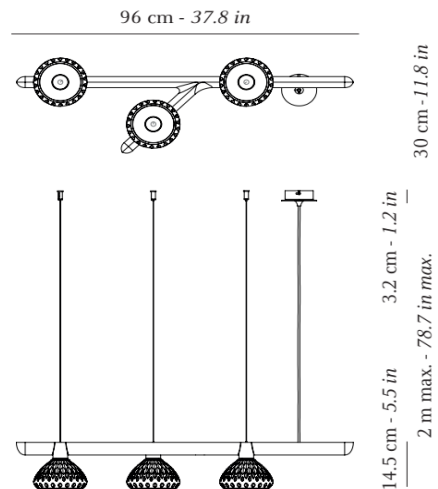

OPTIONAL CONFIGURATIONS

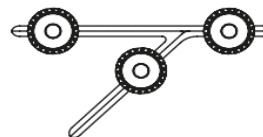

78 x 43 cm (30.7 in x 16.9 in)

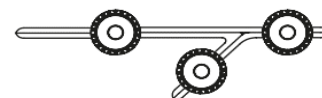

96 x 30 cm (37.8 in x 11.8 in)

3-LIGHTS FOLIA RIGHT SUSP UNIT

TECHNICAL DATA SHEET



FEATURES

Product name 3-LIGHTS FOLIA RIGHT SUSP UNIT
 Code **7Y03aRbcddee**
 a = 1 : Europe / 3 : US
 b = 1 : gold / 2 : chrome plated
 c = 6 : dark ash / 7 : clear ash / 8 : white ash
 ee = (use 1 digit in a) Ø : version standard /
 CN : China version (CCC) / SA : Middle East
 version / TW : Taiwan version (BSMI) / EG :
 Egypt version / MA : Morocco version / GB :
 United Kingdom version
 (use 3 digit in a) US : USA version / JP : Japan
 version

Material Gold brushed anodized aluminium / chrome
 plated aluminium, ash wood, clear crystal

Electrical class Class II
 220-240V 50/60Hz (EUROPE, GB, CN, SA, SG
 VERSION)

Voltage 100-127V 50/60Hz (US, JP VERSION)

IP 20

Installation Inside

Mounting Suspension

DIMENSIONS

L x l 96cm (37,8in) x 30cm (11,8in)

Height 14,5cm (5,5in)

Weight 4,2 kg

Adjustable height 2m max. (78,7in max.)

NOT INCLUDED SOURCES

Category HALOGEN
 Quantity 3
 Lbs D45
 Watt 40 W max.
 Socket E14 (EUROPE, SASO & CHINA VERSION)
 E12 (US VERSION)

ALTERNATIVE SOURCES

Category LED RETROFIT
 Quantity 3
 Lbs D45
 Watt 5 W max.
 Socket E14 (EUROPE, SASO & CHINA VERSION)
 E12 (US VERSION)

ELECTRICAL DIAGRAM

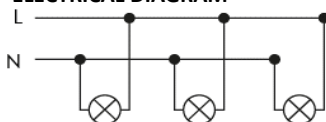

MAINTENANCE



SILHOUETTE

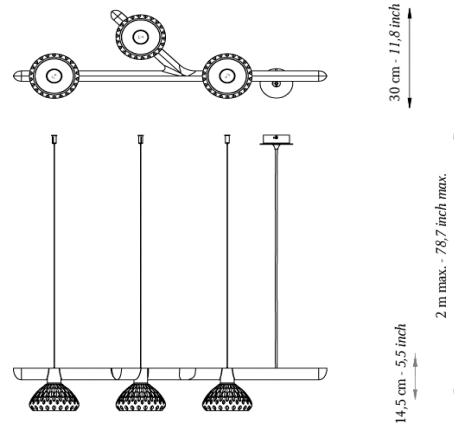

OPTIONAL CONFIGURATIONS

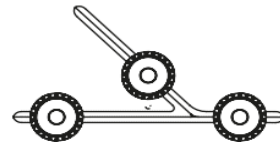

78 x 43 cm (30.7 in x 16.9 in)

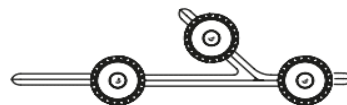

96 x 30 cm (37.8 in x 11.8 in)

5-LIGHTS FOLIA 45° SUSP UNIT TECHNICAL DATA SHEET



FEATURES

Product name 5-LIGHTS FOLIA 45° SUSP UNIT
Code **7Y05aVbcddee**
a = 1 : Europe / 3 : US
b = 1 : gold / 2 : chrome plated
c = 6 : dark ash / 7 : clear ash / 8 : white ash
dd = 00 : clear crystal / 25 : chartreuse green crystal / ZZ : without crystal
ee = (use 1 digit in a) Ø : version standard / CN : China version (CCC) / SA : Middle East version / TW : Taiwan version (BSMI) / EG : Egypt version / MA : Morocco version / GB : United Kingdom version
(use 3 digit in a) US : USA version / JP : Japan version

Material Gold brushed anodized aluminium / chrome plated aluminium, ash wood, clear crystal

Electrical class Class II
220-240V 50/60Hz (EUROPE, GB, CN, SA, SG VERSION)

Voltage 100-127V 50/60Hz (US, JP VERSION)

IP 20

Installation Inside

Mounting Suspension

DIMENSIONS

L x l 130cm (51,2in) x 54cm (21,3in)

Height 14,5cm (5,5in)

Weight 7,5 kg

Adjustable height 2m max. (78,7in max.)

NOT INCLUDED SOURCES

Category HALOGEN
Quantity 5
Lbs D45
Watt 40 W max.
Socket E14 (EUROPE, SASO & CHINA VERSION)
E12 (US VERSION)

ALTERNATIVE SOURCES

Category LED RETROFIT
Quantity 5
Lbs D45
Watt 5 W max.
Socket E14 (EUROPE, SASO & CHINA VERSION)
E12 (US VERSION)

ELECTRICAL DIAGRAM

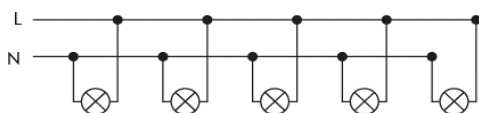

MAINTENANCE

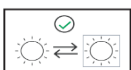

SILHOUETTE

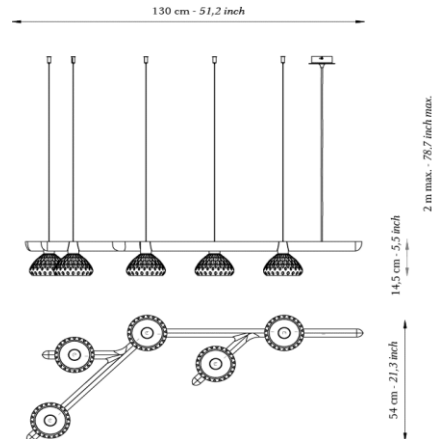

OPTIONAL CONFIGURATIONS

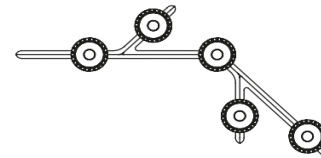

130 x 69 cm (51.2 in x 27.2 in)

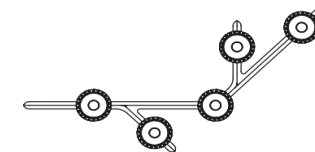

130 x 69 cm (51.2 in x 27.2 in)

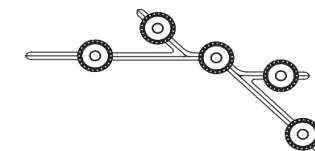

130 x 69 cm (51.2 in x 27.2 in)

7-LIGHTS FOLIA LINEAR SUSP UNIT

TECHNICAL DATA SHEET



FEATURES

Product name 7-LIGHTS FOLIA LINEAR SUSP UNIT
 Code **7Y07a5bcddee**
 a = 1 : Europe / 3 : US
 b = 1 : gold / 2 : chrome plated
 c = 6 : dark ash / 7 : clear ash / 8 : white ash
 dd = 00 : clear crystal / 25 : chartreuse green crystal / ZZ : without crystal
 ee = (use 1 digit in a) Ø : version standard / CN : China version (CCC) / SA : Middle East version / TW : Taiwan version (BSMI) / EG : Egypt version / MA : Morocco version / GB : United Kingdom version
 (use 3 digit in a) US : USA version / JP : Japan version

Material Gold brushed anodized aluminium / chrome plated aluminium, ash wood, clear crystal
 Electrical class Class II
 220-240V 50/60Hz (EUROPE, GB, CN, SA, SG VERSION)
 Voltage 100-127V 50/60Hz (US, JP VERSION)
 IP 20
 Installation Inside
 Mounting Suspension

DIMENSIONS

L x l 202cm (79,5in) x 45cm (17,7in)
 Height 14,5cm (5,5in)
 Weight 11 kg
 Adjustable height 2m max. (78,7in max.)

NOT INCLUDED SOURCES

Category HALOGEN
 Quantity 7
 Lbs D45
 Watt 40 W max.
 Socket E14 (EUROPE, SASO & CHINA VERSION)
 E12 (US VERSION)

ALTERNATIVE SOURCES

Category LED RETROFIT
 Quantity 7
 Lbs D45
 Watt 5 W max.
 Socket E14 (EUROPE, SASO & CHINA VERSION)
 E12 (US VERSION)

ELECTRICAL DIAGRAM

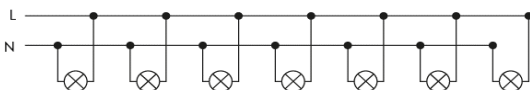

MAINTENANCE



SILHOUETTE

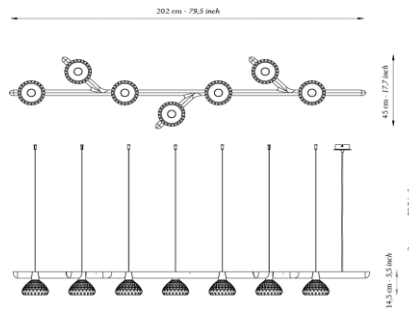

OPTIONAL CONFIGURATIONS

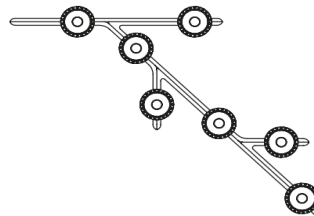

141 x 105 cm (55.5 in x 41.3 in)

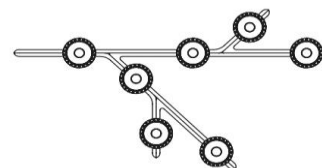

149 x 82 cm (58.7 in x 32.3 in)

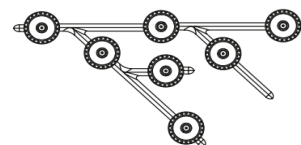

130 x 66 cm (51.2 in x 26 in)

7-LIGHTS FOLIA 45° SUSP UNIT
TECHNICAL DATA SHEET



FEATURES

Product name 7-LIGHTS FOLIA 45° SUSP UNIT
Code **7Y07aVbcddee**
a = 1 : Europe / 3 : US
b = 1 : gold / 2 : chrome plated
c = 6 : dark ash / 7 : clear ash / 8 : white ash
dd = 00 : clear crystal / 25 : chartreuse green crystal / ZZ : without crystal
ee = (use 1 digit in a) Ø : version standard / CN : China version (CCC) / SA : Middle East version / TW : Taiwan version (BSMI) / EG : Egypt version / MA : Morocco version / GB : United Kingdom version
(use 3 digit in a) US : USA version / JP : Japan version

Material Gold brushed anodized aluminium / chrome plated aluminium, ash wood, clear crystal

Electrical class Class II
220-240V 50/60Hz (EUROPE, GB, CN, SA, SG VERSION)

Voltage 100-127V 50/60Hz (US, JP VERSION)

IP 20

Installation Inside

Mounting Suspension

DIMENSIONS

L x l 143cm (56,3in) x 125cm (49,2in)

Height 14,5cm (5,5in)

Weight 11 kg

Adjustable height 2m max. (78,7in max.)

NOT INCLUDED SOURCES

Category HALOGEN
Quantity 7
Lbs D45
Watt 40 W max.
Socket E14 (EUROPE, SASO & CHINA VERSION)
E12 (US VERSION)

ALTERNATIVE SOURCES

Category LED RETROFIT
Quantity 7
Lbs D45
Watt 5 W max.
Socket E14 (EUROPE, SASO & CHINA VERSION)
E12 (US VERSION)

ELECTRICAL DIAGRAM

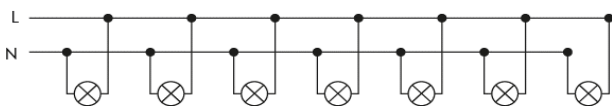

MAINTENANCE



SILHOUETTE

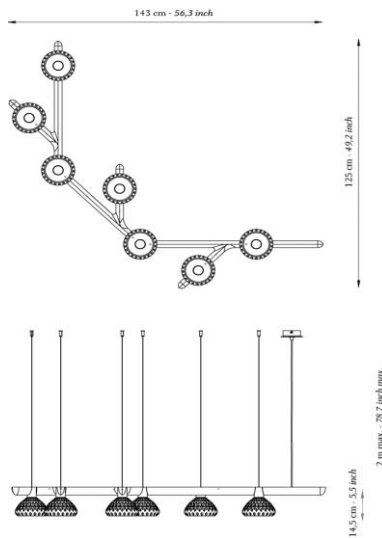

OPTIONAL CONFIGURATIONS

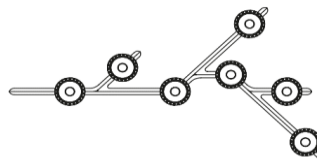

158 x 84 cm (62.2 in x 33.1 in)

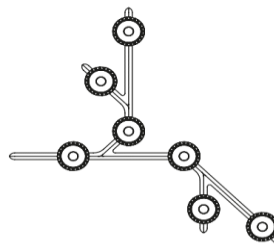

130 x 125 cm (51.2 in x 49.2 in)

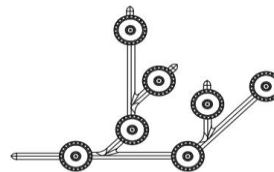

130 x 86 cm (51.2 in x 33.9 in)

* : The references of this product range are totally or partly covered by these certifications. Please check with customer service before ordering

16-LIGHTS FOLIA CIRCULAR SUSP UNIT

TECHNICAL DATA SHEET



FEATURES

Product name 16-LIGHTS FOLIA CIRCULAR SUSP UNIT
 Code **7Y16aCbcddee**
 a = 1 : Europe / 3 : US
 b = 1 : gold / 2 : chrome plated
 c = 6 : dark ash / 7 : clear ash / 8 : white ash
 dd = 00 : clear crystal / 25 : chartreuse green crystal / ZZ : without crystal
 ee = (use 1 digit in a) Ø : version standard / CN : China version (CCC) / SA : Middle East version / TW : Taiwan version (BSMI) / EG : Egypt version / MA : Morocco version / GB : United Kingdom version (use 3 digit in a) US : USA version / JP : Japan version

Material Gold brushed anodized aluminium / chrome plated aluminium, ash wood, clear crystal
 Electrical class Class II
 220-240V 50/60Hz (EUROPE, GB, CN, SA, SG VERSION)
 Voltage 100-127V 50/60Hz (US, JP VERSION)
 IP 20
 Installation Inside
 Mounting Suspension

DIMENSIONS

L x l 143 cm (56,3in) x 143 cm (56,3in)
 Height 14,5 cm (5,5in)
 Weight 24 kg
 Adjustable height 2m max. (78,7in max.)

NOT INCLUDED SOURCES

Category HALOGEN
 Quantity 16
 Lbs D45
 Watt 40 W max.
 Socket E14 (EUROPE, SASO & CHINA VERSION)
 E12 (US VERSION)

ALTERNATIVE SOURCES

Category LED RETROFIT
 Quantity 16
 Lbs D45
 Watt 5 W max.
 Socket E14 (EUROPE, SASO & CHINA VERSION)
 E12 (US VERSION)

ELECTRICAL DIAGRAM

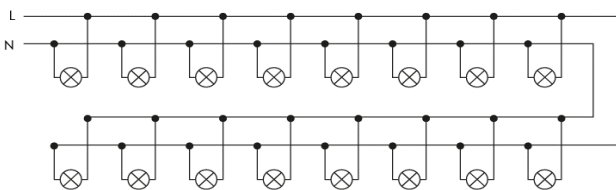

MAINTENANCE



SILHOUETTE

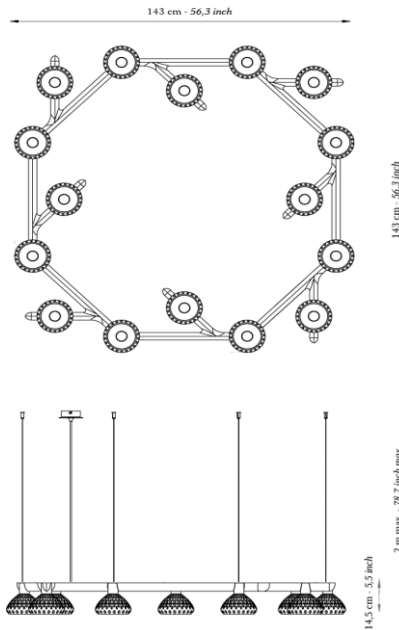

OPTIONAL CONFIGURATIONS

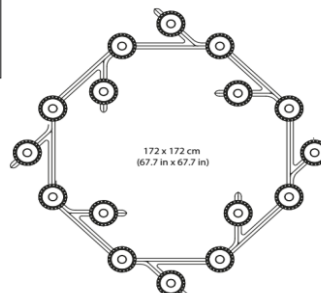
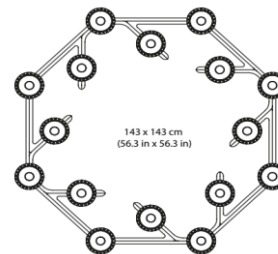
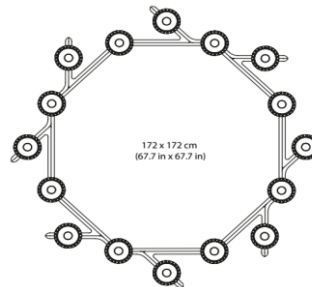

20-LIGHTS FOLIA SUSP OVAL UNIT

TECHNICAL DATA SHEET



FEATURES

Product name 20-LIGHTS FOLIA SUSP OVAL UNIT
 Code **7Y20aObcdddee**
 a = 1 : Europe / 3 : US
 b = 1 : gold / 2 : chrome plated
 c = 6 : dark ash / 7 : clear ash / 8 : white ash
 dd = 00 : clear crystal / 25 : chartreuse green crystal / ZZ : without crystal
 ee = (use 1 digit in a) Ø : version standard / CN : China version (CCC) / SA : Middle East version / TW : Taiwan version (BSMI) / EG : Egypt version / MA : Morocco version / GB : United Kingdom version
 (use 3 digit in a) US : USA version / JP : Japan version

Material Gold brushed anodized aluminium / chrome plated aluminium, ash wood, clear crystal

Electrical class Class II
 220-240V 50/60Hz (EUROPE, GB, CN, SA, SG VERSION)

Voltage 100-127V 50/60Hz (US, JP VERSION)
 IP 20

Installation Inside
 Mounting Suspension

DIMENSIONS

L x l 196 cm (77,2in) x 143 cm (56,3in)
 Height 14,5 cm (5,5in)
 Weight 30 kg
 Adjustable height 2m max. (78,7in max.)

NOT INCLUDED SOURCES

Category HALOGEN
 Quantity 16
 Lbs D45
 Watt 40 W max.
 Socket E14 (EUROPE, SASO & CHINA VERSION)
 E12 (US VERSION)

ALTERNATIVE SOURCES

Category LED RETROFIT
 Quantity 16
 Lbs D45
 Watt 5 W max.
 Socket E14 (EUROPE, SASO & CHINA VERSION)
 E12 (US VERSION)

ELECTRICAL DIAGRAM

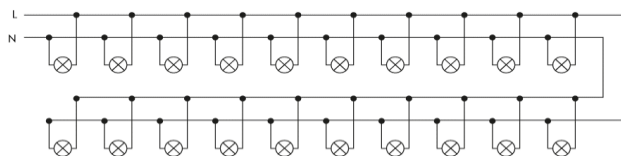

MAINTENANCE



SILHOUETTE

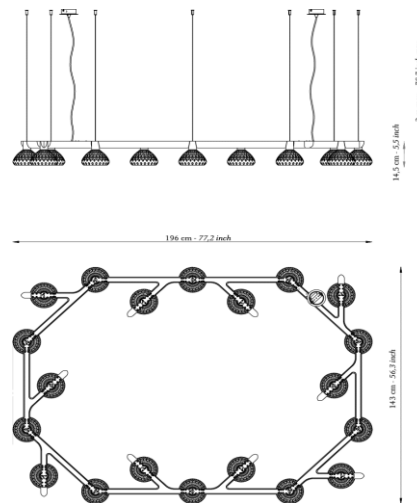

OPTIONAL CONFIGURATIONS

